

# AHS 30 Variante

Montageanleitung / Notice de montage / Assembly instruction

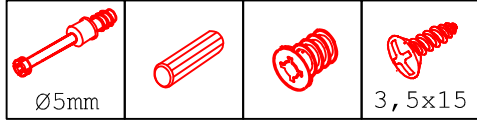

12x 34x 20x 10x



12x

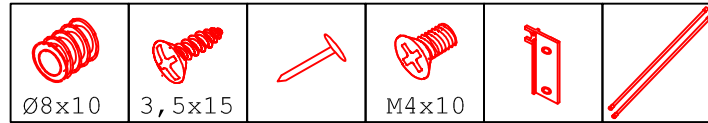

20x 56x 15x 20x 8x 4x

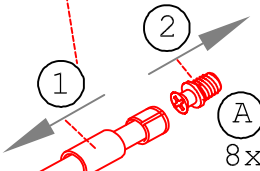
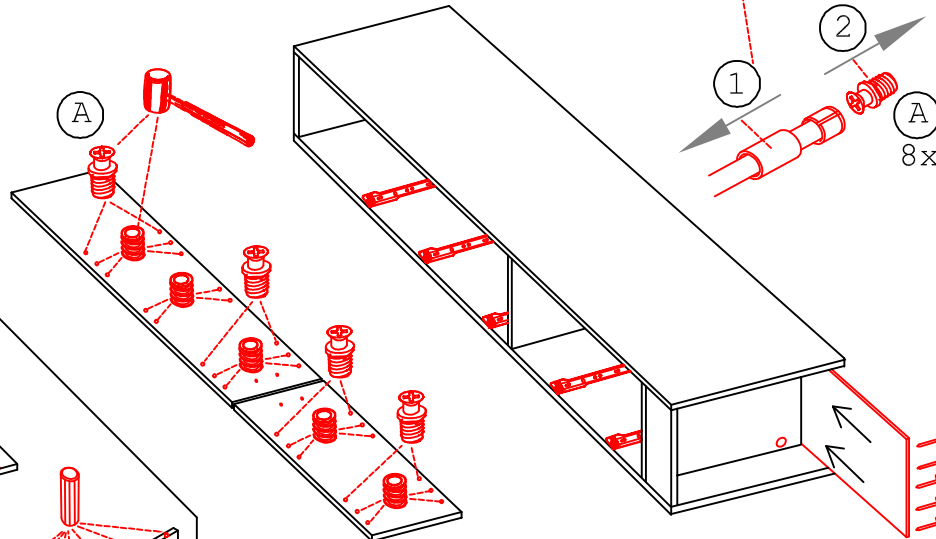

8x

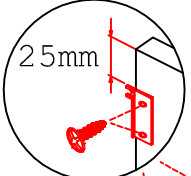
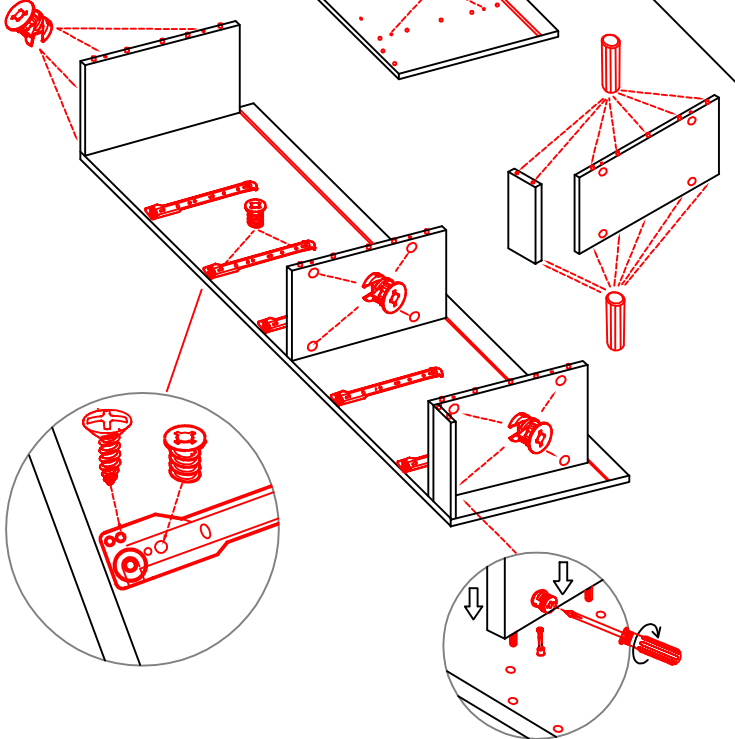

25mm

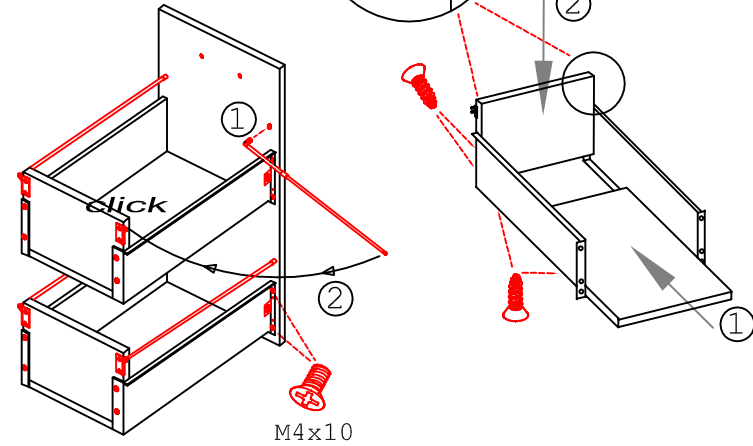

M4x10

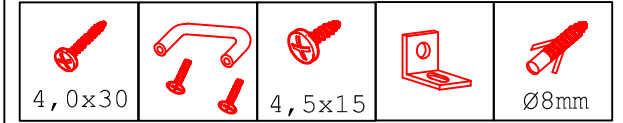

4x 2x 1x 1x 1x

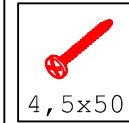

4,5x50

1x

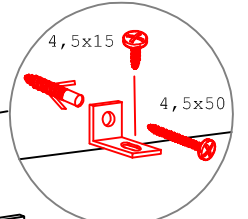

4,5x15

4,5x50

**Kippsicherung !!!**

Schrank und Wand  
mittels Winkel  
verbinden (auf dem  
oberen Boden)

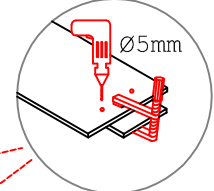

Ø5mm

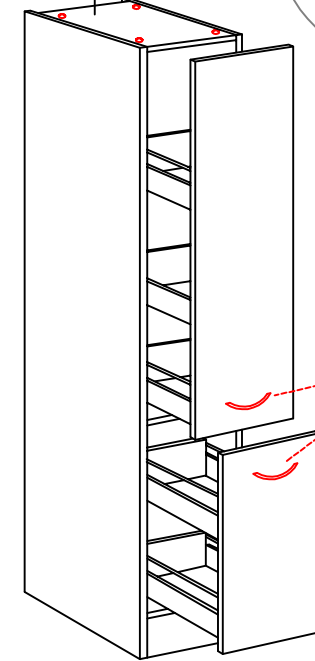

Die Einstellung der  
Auszug-Blenden bitte  
durch drehen an den  
einzelnen Reihling-  
stangen vornehmen.  
(heranhohlen oder  
wegdrücken)

