

6145008

AVITAL®

ZINNA

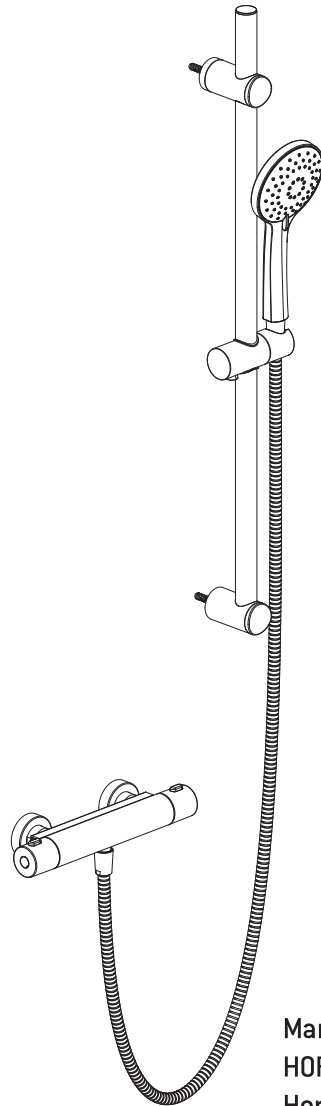

Manufactured for
HORNACH Baumarkt AG
Hornbachstrasse 11
76879 Bornheim/Germany
www.hornbach.com
version number [20190618 V02]

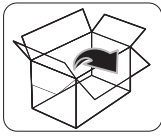

- ST4.2×35 ST4.2×63.5
- A1×1 A2×1
- Ø8×36
- A3×2 A4×2 A5×1
- A6×1

B



C

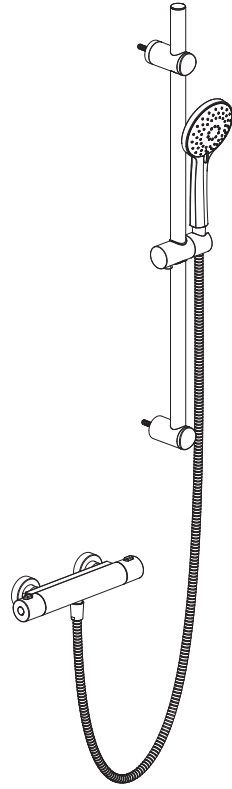

D

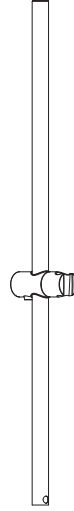

E

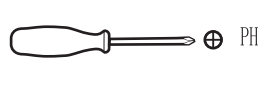
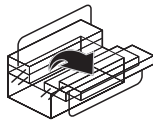
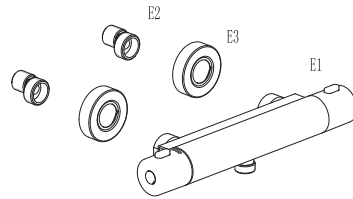

PH

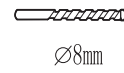

Ø8mm

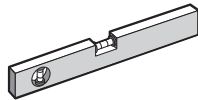

30'



1

1

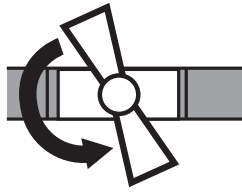

2

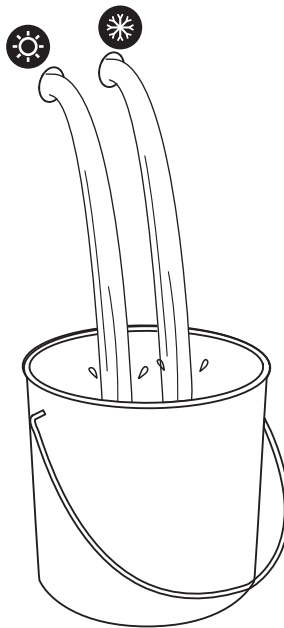

3

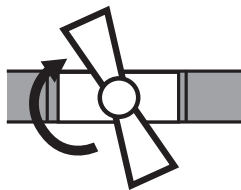

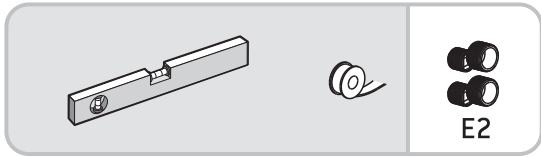
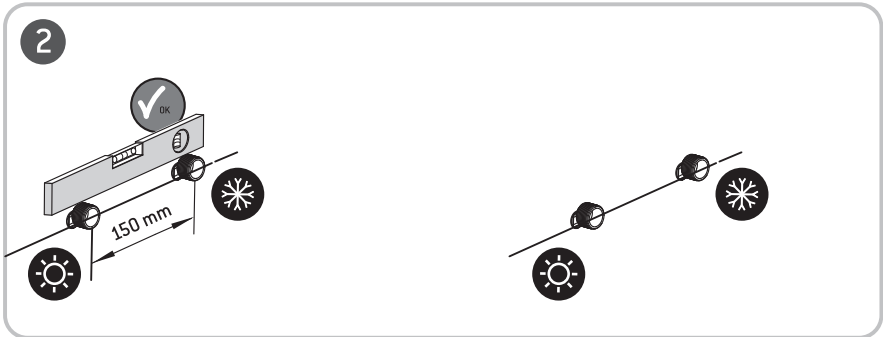
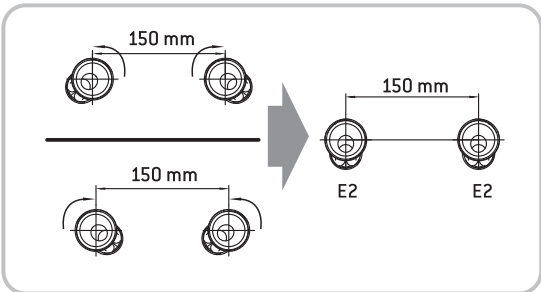
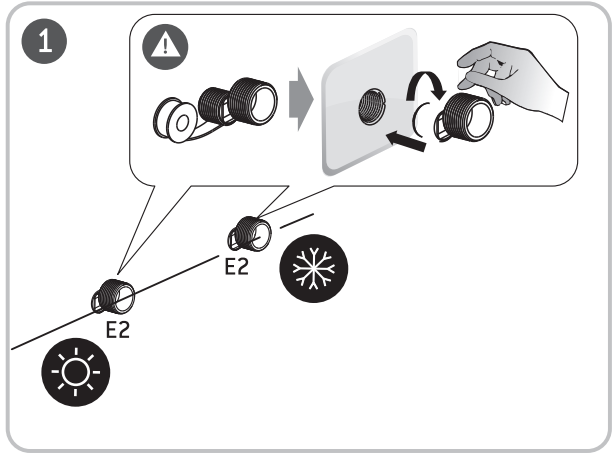

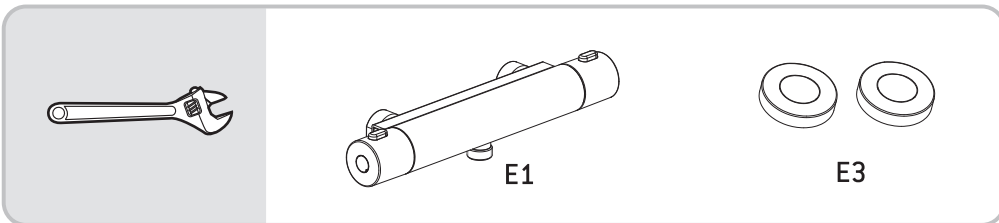
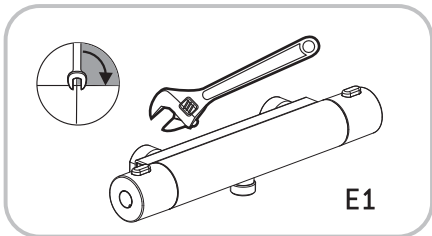
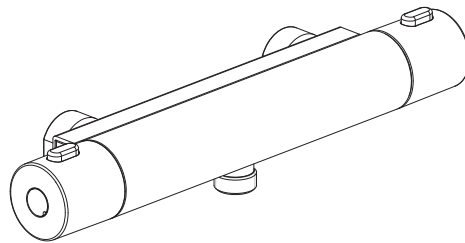
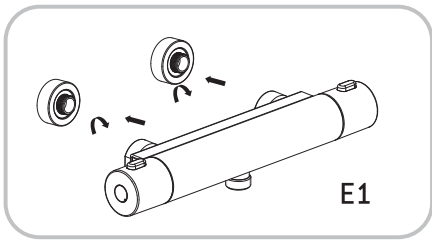
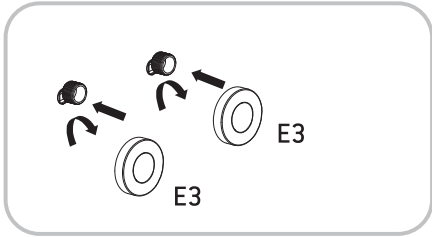

4

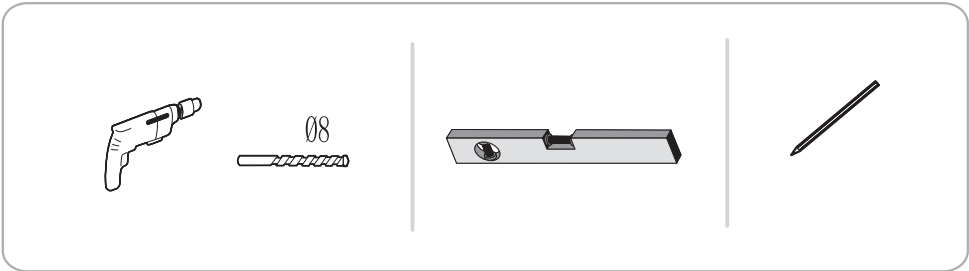
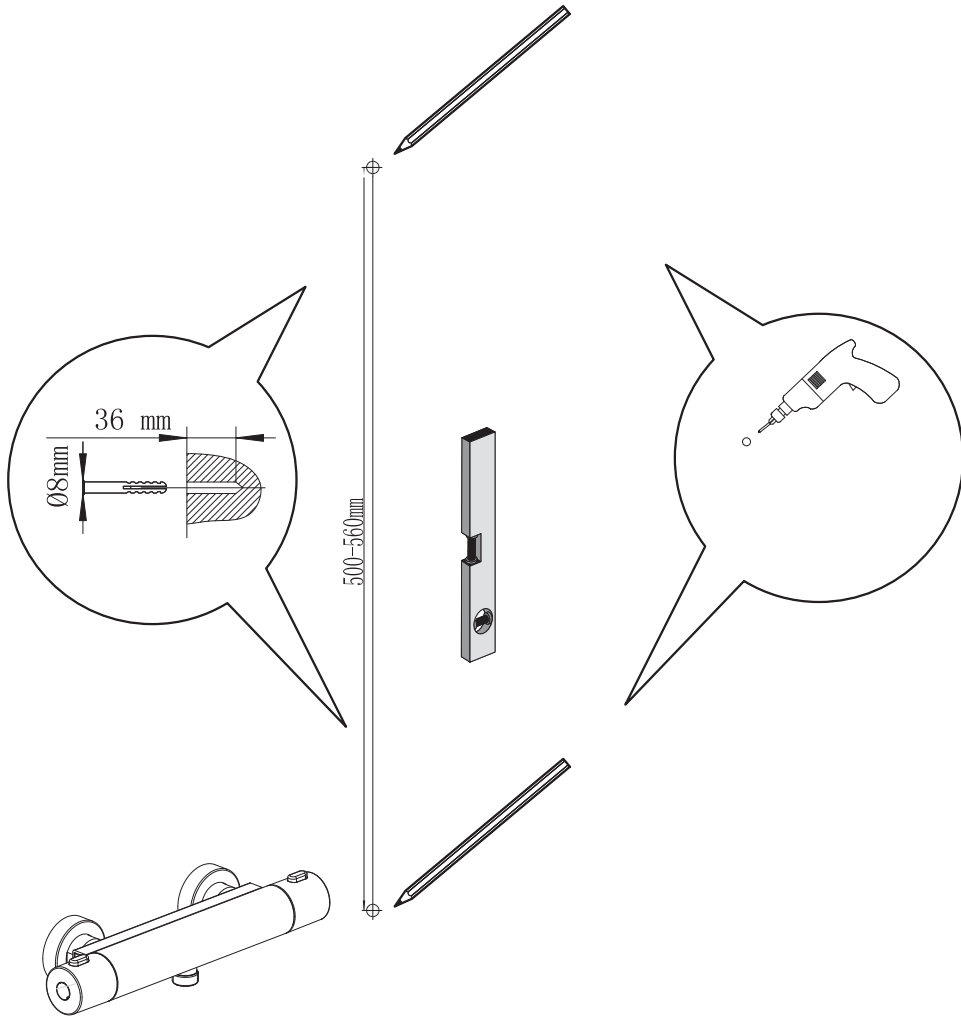

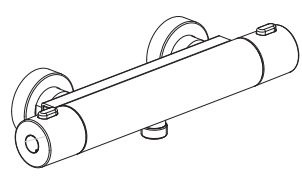
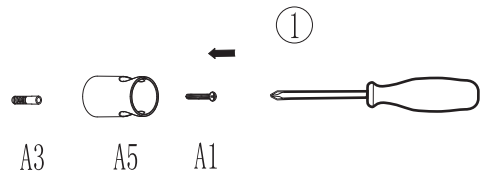



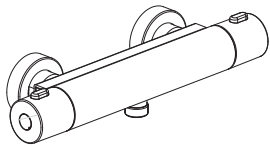
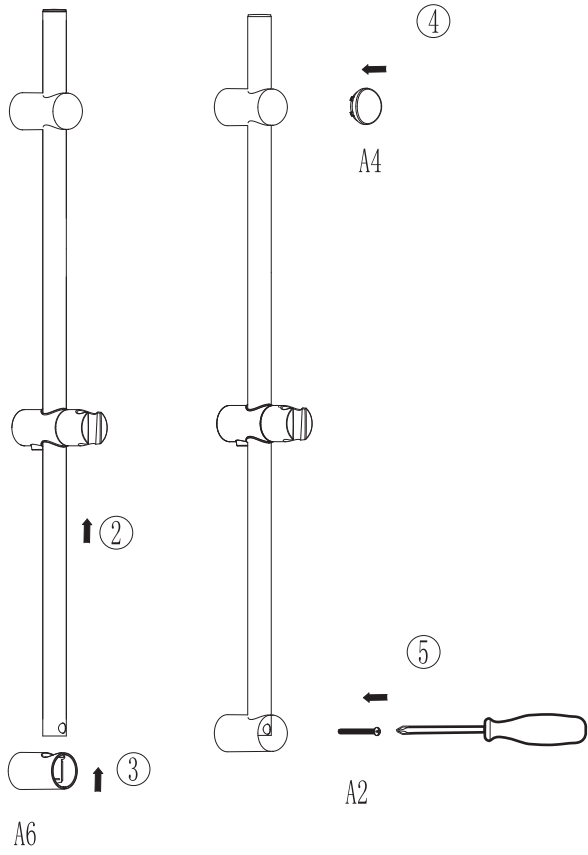

 ⊕ PH	ST4.2×35  A1×1	8X36mm  A3×2	 A5×1
--	---	---	---

6



 PH	ST4.2X63.5  A2X1	 A6X1	 A4X1
			
	c		

