

Fig. 1

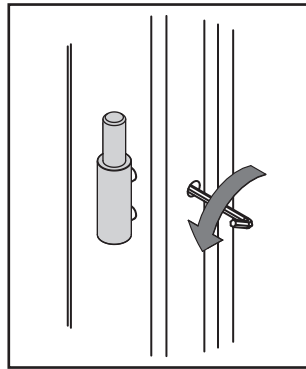

Fig. 2

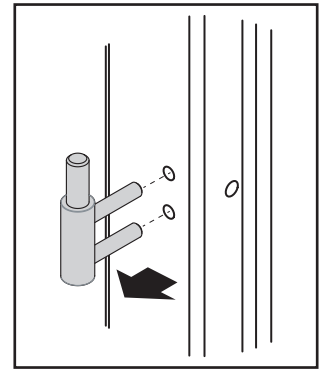

Fig. 3

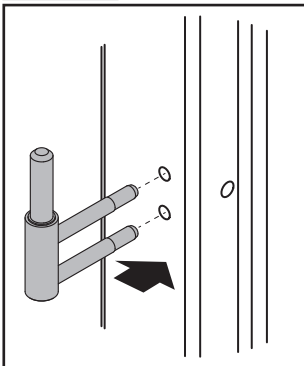
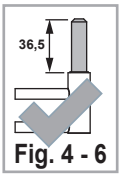

Fig. 4

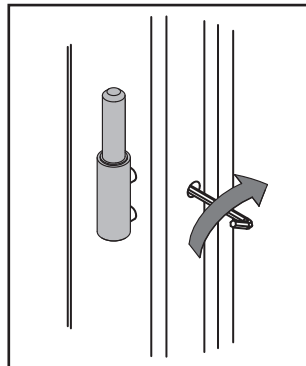

Fig. 5

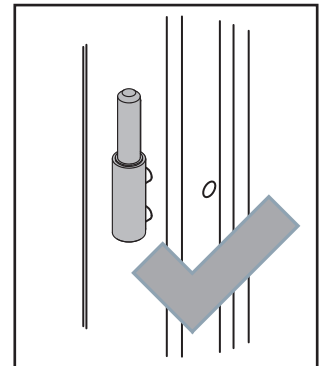

Fig. 6

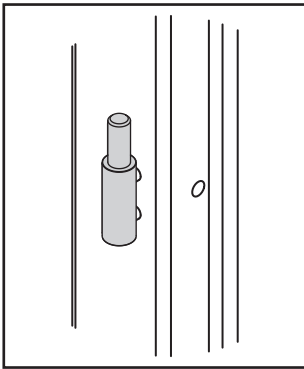
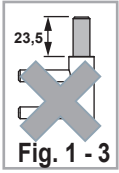
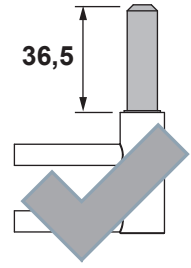
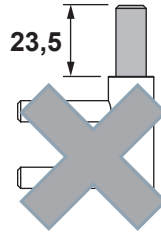
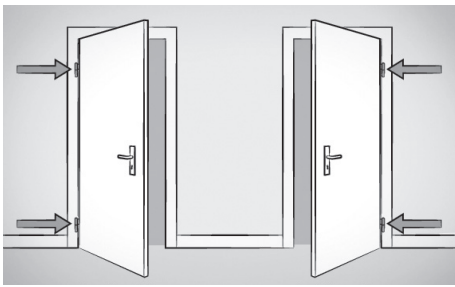

Fig. 1

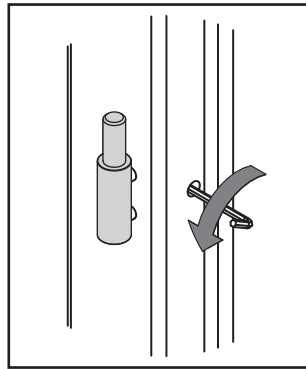

Fig. 2

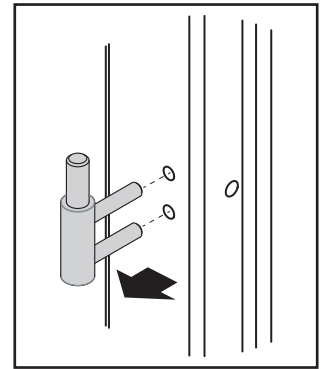

Fig. 3

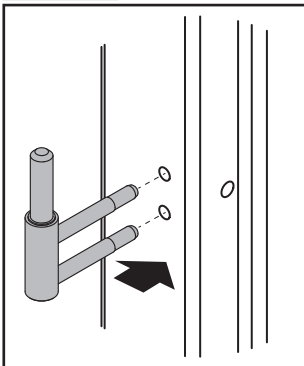
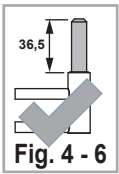

Fig. 4

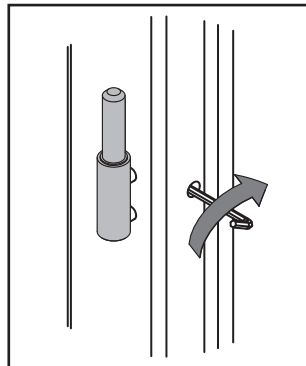

Fig. 5

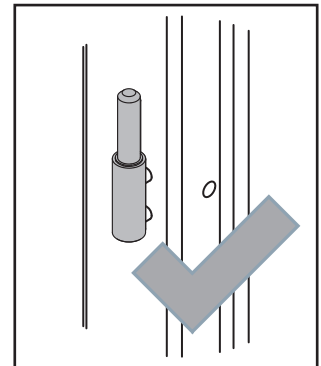

Fig. 6