

















MONTAGEANLEITUNG

-  MONTAGEANLEITUNG
-  ASSEMBLY INSTRUCTION
-  DE INSTRUCTIE VAN DE ASSEMBLAGE
-  ISTRUZIONE DELL'ASSEMBLEA
-  INSTRUCCIÓN DE ASAMBLEA
-  INSTRUCTION DE MONTAGE
-  NÁVOD K MONTÁŽI
-  MONTERINGSANVISNING

-  MONTAJ TALIMATI
-  ASENNUSOHJE
-  BRUGSANVISNING
-  BRUKSANVISNING
-  UPUTE ZA MONTAŽU
-  NAVODILA ZA MONTAŽO
-  SZERELÉSI ÚTMUTATÓ
-  INSTRUCIUNI DE MONTAJ



Modell-Nr.

12020

Friedrich Küpper GmbH
Friedrich-Küpper-Weg
54570 Berlingen
Deutschland

Telefon +49 (0) 65 91 - 95 42 0
Telefax +49 (0) 65 91 - 95 42 17
E-Mail info@friedrich-kuepper-gmbh.de
Internet www.friedrich-kuepper-gmbh.de

ART.-NR. FRONT KORPUS

12021 Grün Silber

12022 Rot (ähnl. RAL 3002) Silber

12024 Blau Silber

12027 Ultramarinblau (RAL 5002) Silber

12026 Silber Schwarz

LIEFERUMFANG / SCOPE OF SUPPLY

EINZELTEILE / PIECES

A



1x

438 mm x 689 mm

B



1x

438 mm x 689 mm

C



1x

477 mm x 506 mm

D



1x

477 mm x 506 mm

E



1x

509 mm x 689 mm

K



1x

435 mm x 400 mm

V

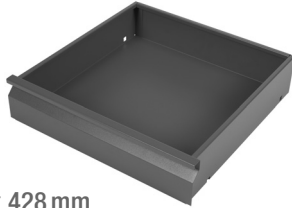

2x

420 mm x 428 mm

N



2x

O



2x

X



2x

450 mm x 20 mm

P



1x

335 mm x 55 mm



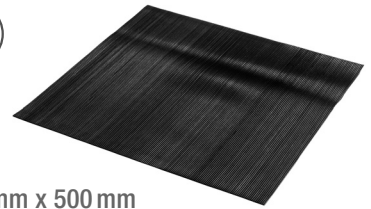











Q





1x

470 mm x 500 mm

BEUTELINHALT / BAG CONTENT

 12x M5 x 10 mm	 24x ø 5,3 mm	 12x M5	 8x M4 x 10 mm	 8x M4	 16x M6 x 10 mm
 16x ø 6,4 mm	 16x M6	 2x M8 x 25 mm	 4x ø 8 mm	 2x M8	 2x
 1x	 1x				

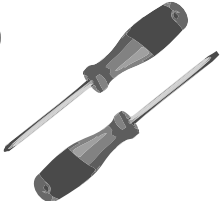
BENÖTIGTES WERKZEUG / NEEDED TOOLS

<p>①</p>  <p>PH 1 x 100 PH 2 x 100</p>	<p>②</p>  <p>SW 7 SW 8 SW 10</p>
-------------------------------------------------------------------------------------------------------------------------------	------------------------------------------------------------------------------------------------------------------------------

1.



2.

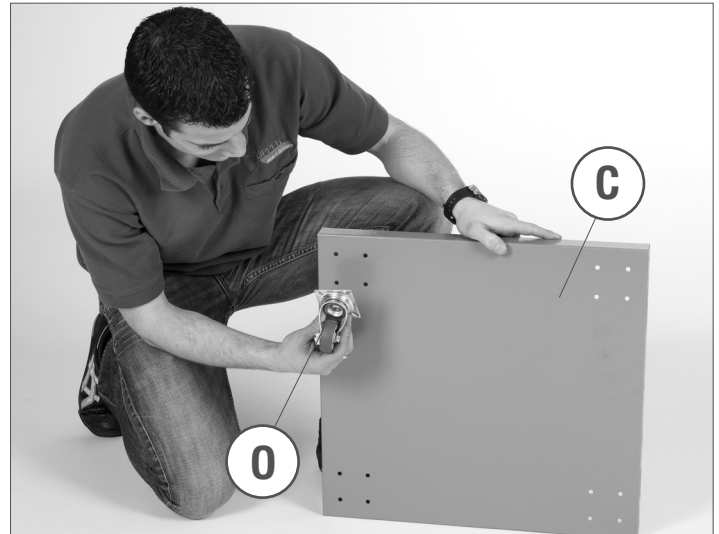

3.

- 16x M6
- 16x M6 x 10
- 16x 6,4 mm
- 2x
- 2x

- 2x SW 10

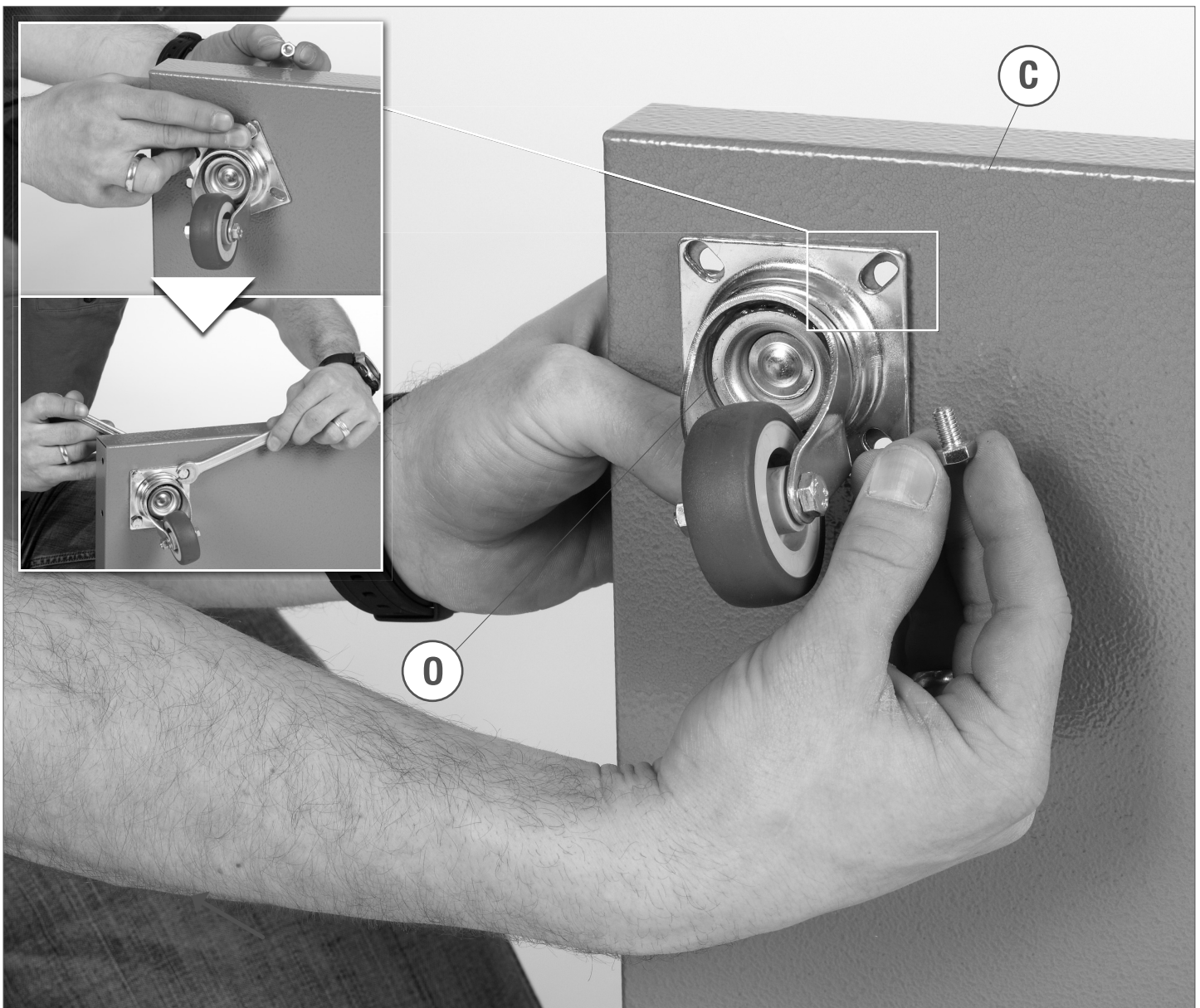

4.

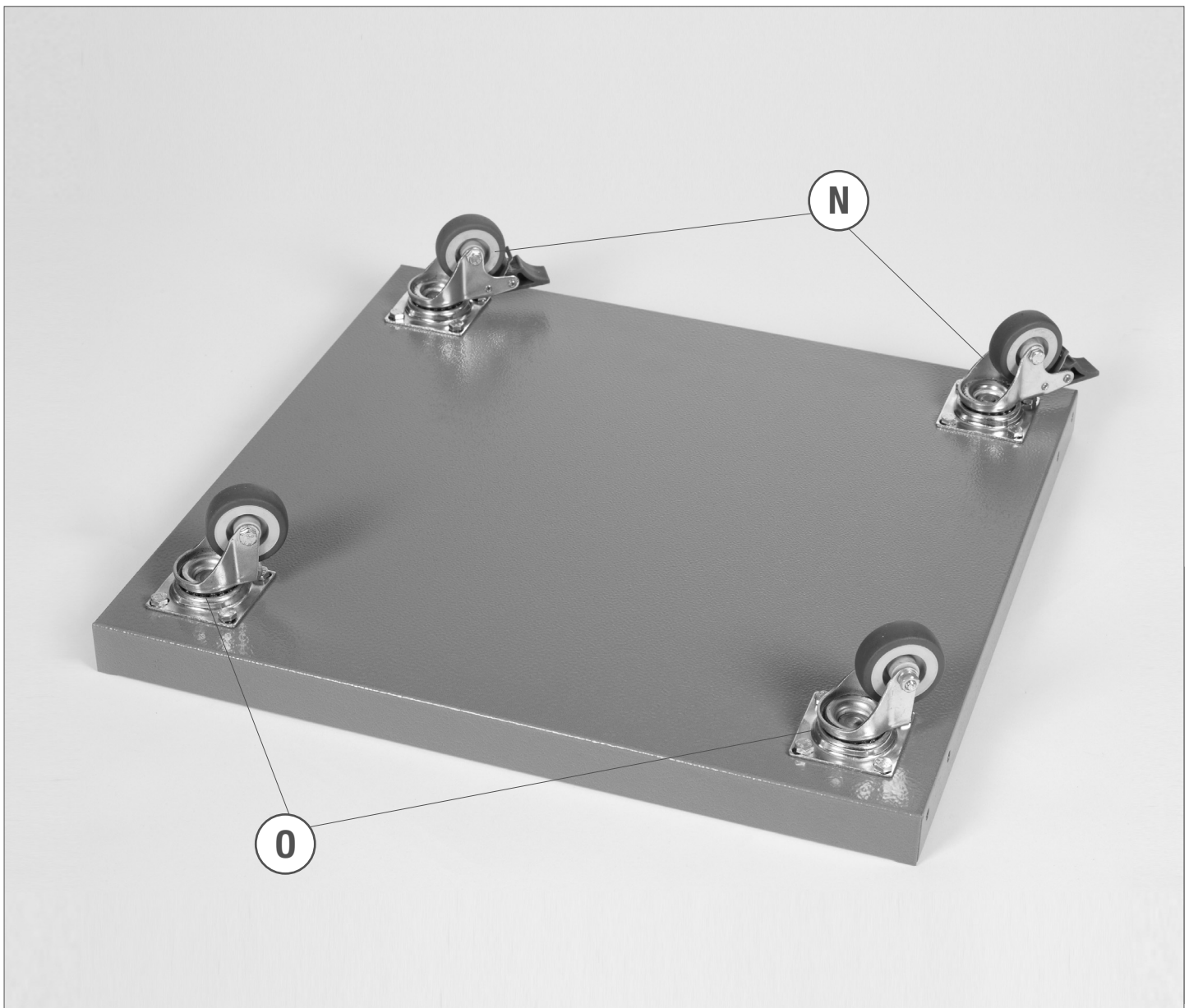

5.

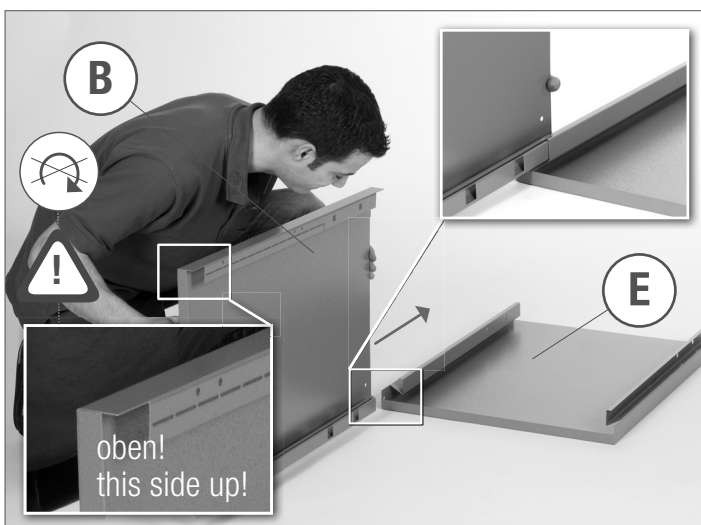

6.

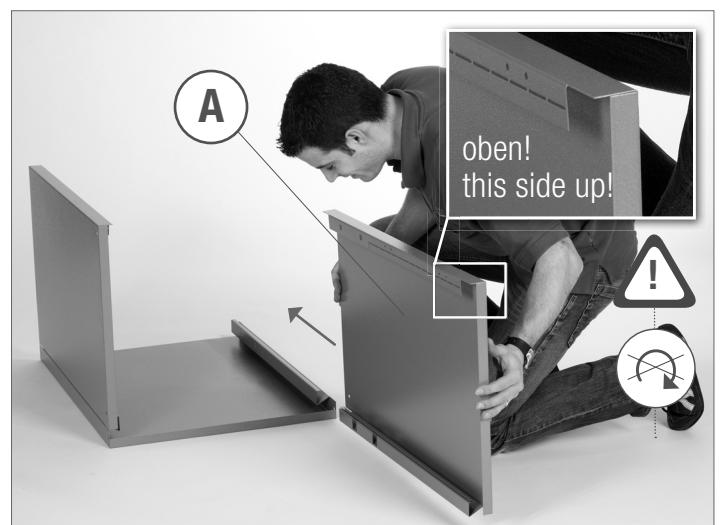

7.



8.



9.



6x M5



6x M5 x 10



12x 5,3mm



SW 8



PH 2 x 100

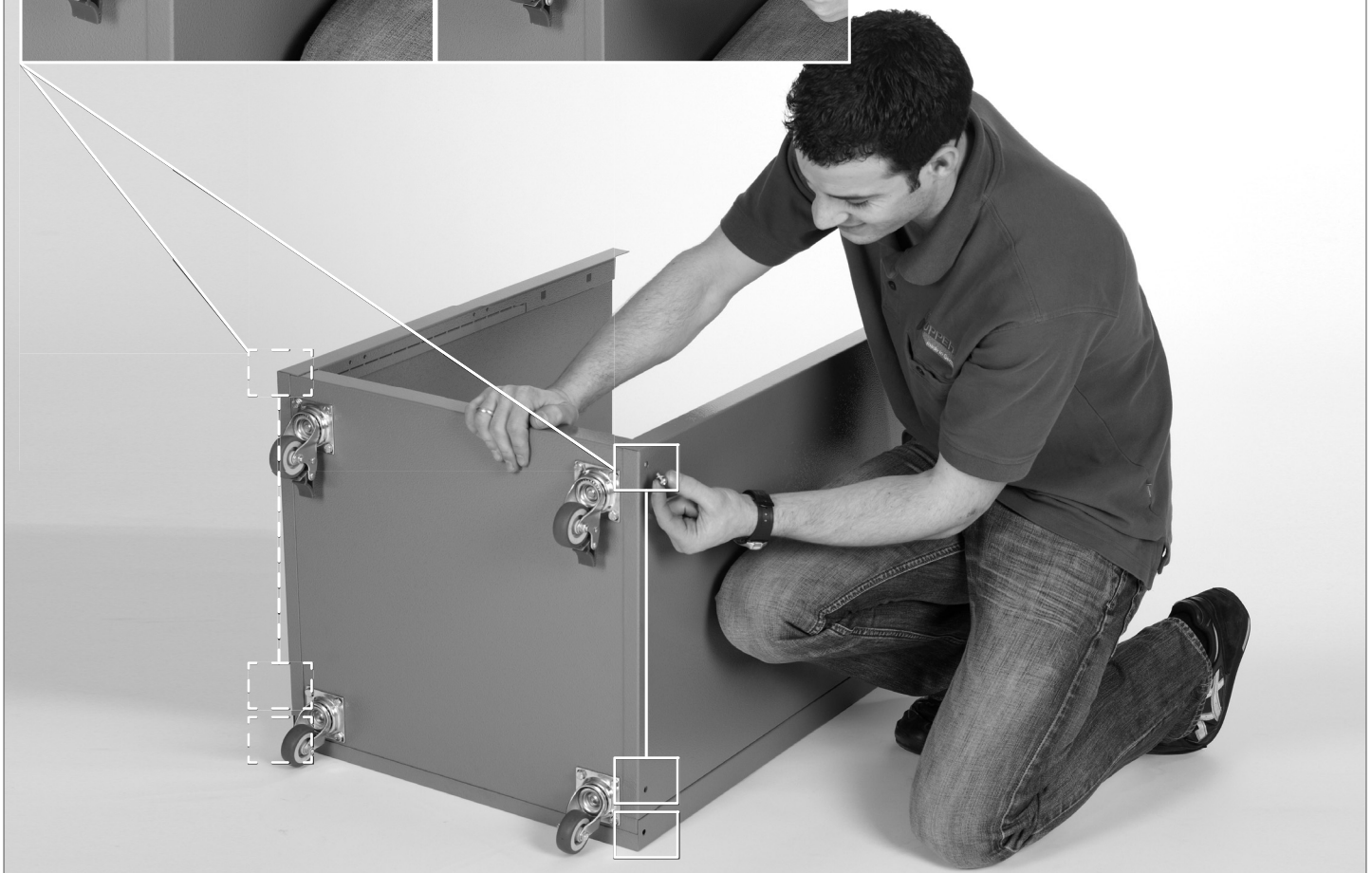
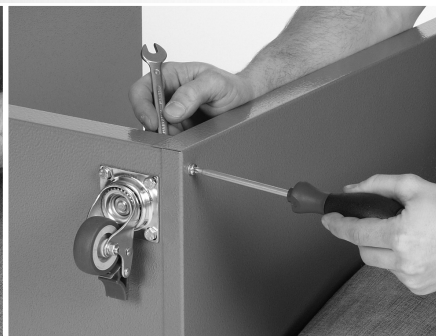

10.



11.



12.

6x M5 6x M5 x 10 12x 5,3 mm

② SW 8 ① PH 2 x 100



13.  2x CR



14.  2x CL

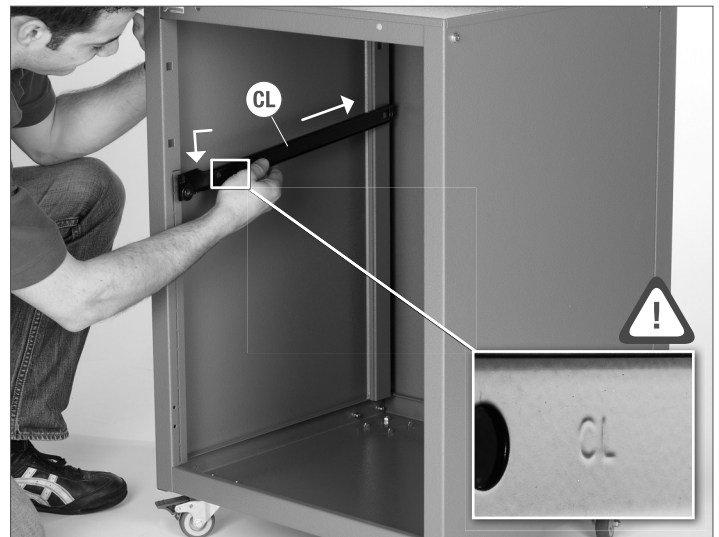

15.  2x DL

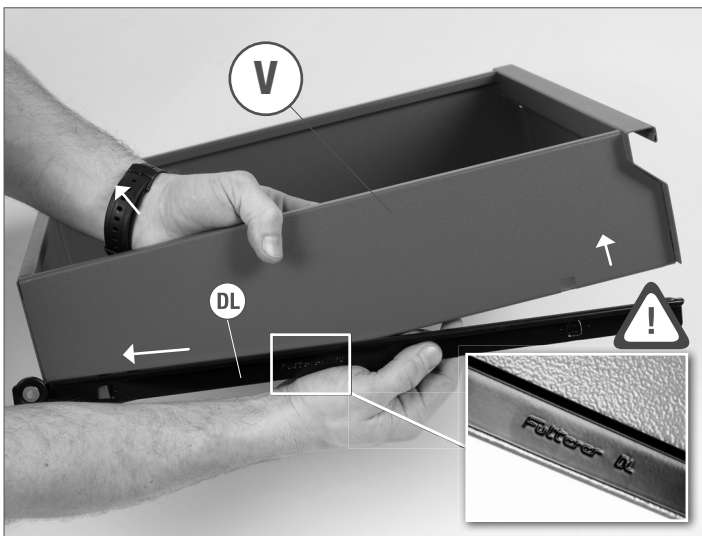

16.  2x DR

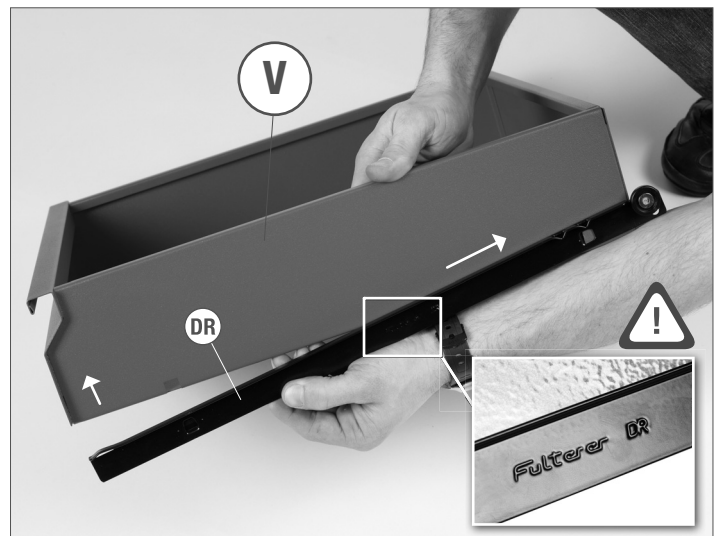

17.



18.



19.



20.



2x



4x M4



4x M4 x 10

②



SW 7

①



PH 1 x 100



21.

4x M4

4x M4x10

② SW7

① PH1x100



22.

1x

1x

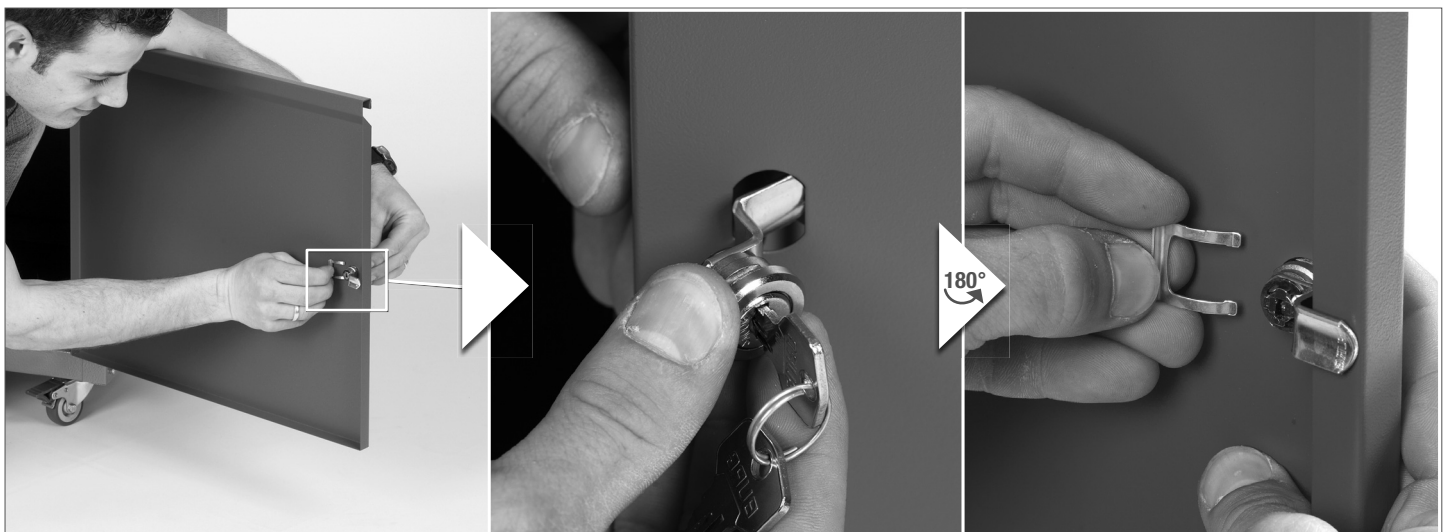

23.  2x M8



24.  4x 8 mm  2x M8 x 25

②  SW 13

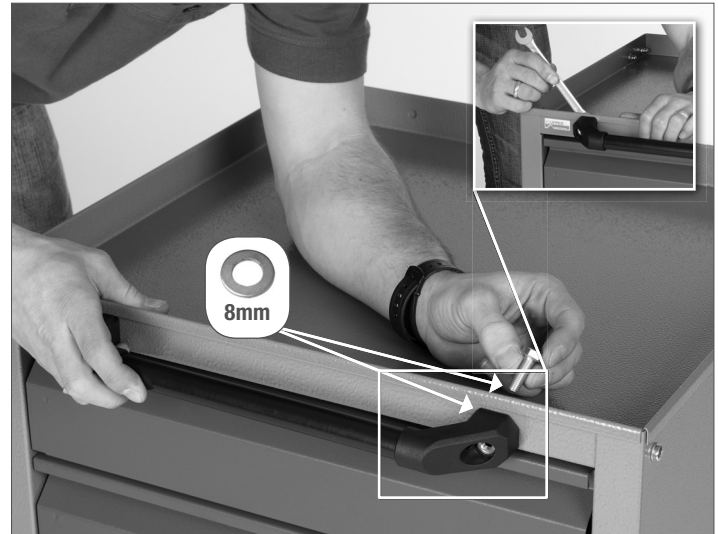

25.





Modell-Nr.

12020