

T1

Bitte unbedingt ausfüllen!

Name _____

Strasse _____

Plz _____ Ort _____

Tel. _____

T2

Sehr geehrte Kunden,
wir freuen uns, dass Sie sich für ein Produkt aus dem Hause Pelipal entschieden haben. Sollte es trotz aller Bemühungen unsererseits, Ihnen ein qualitativ hochwertiges Möbelstück zu liefern, zu Fehlteilen kommen, schicken Sie bitte dieses ausgefüllte Blatt an
Fax.: **+49 3443/434354**
E-Mail: **weisenfels.ersatzteile@pelipal.de**
Bitte beachten Sie, dass Bauteile über 800mm Länge und 350mm Breite direkt bei Ihrem Möbelhändler zu beanstanden sind. Zur Reklamationsbearbeitung ist es unbedingt erforderlich **die Artikelnummer des Schrankes**, welche auf dem Etikett ersichtlich ist und den Markt, wo das Möbel erworben wurde anzugeben. Ausserdem tragen Sie unten bitte die benötigte Stückzahl ein. Viel Spass mit Ihrem neuen Badmöbel! Ihr Pelipal Team

_____ - _____

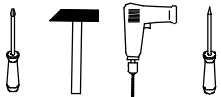









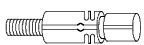

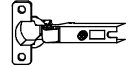

T3

Für den Zusammenbau sind 2 Personen erforderlich.

T4

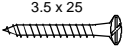
Montage-Richtzeit 3 Stunden

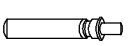
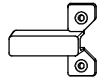
8 x a  DÜB-SMD-000005	Stück	8 x b  EXZENTER-000015	Stück	2 x c  ZPL-003X000	Stück	2 x d  TBD-35-115X00	Stück	1 x e  GRI-160-	Stück
8 x f  TRÄ-001-000020	Stück	2 x g  AUF-001-000060	Stück	2 x h  AUF-001-000020	Stück	2 x j  SCH-KNO-M04	Stück	6 x k  3.5 x 15 SCH-SPA-035X015	Stück
10 x l  NAGEL-025X001	Stück	2 x m  3.5 x 25 SCH-SPA-035X025	Stück	2 x n  5 x 8 ADK-AL1-005X008	Stück	1 x o  TÜR-DÄM-000010	Stück	1 x p  TÜR-ADA-000010	Stück

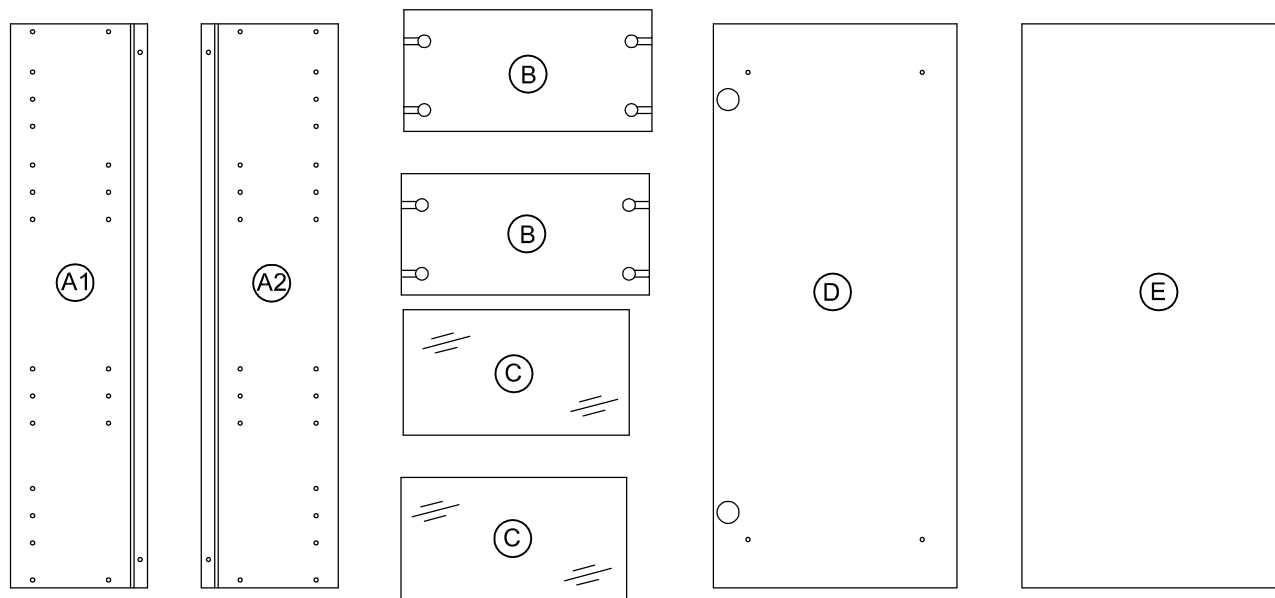

1.

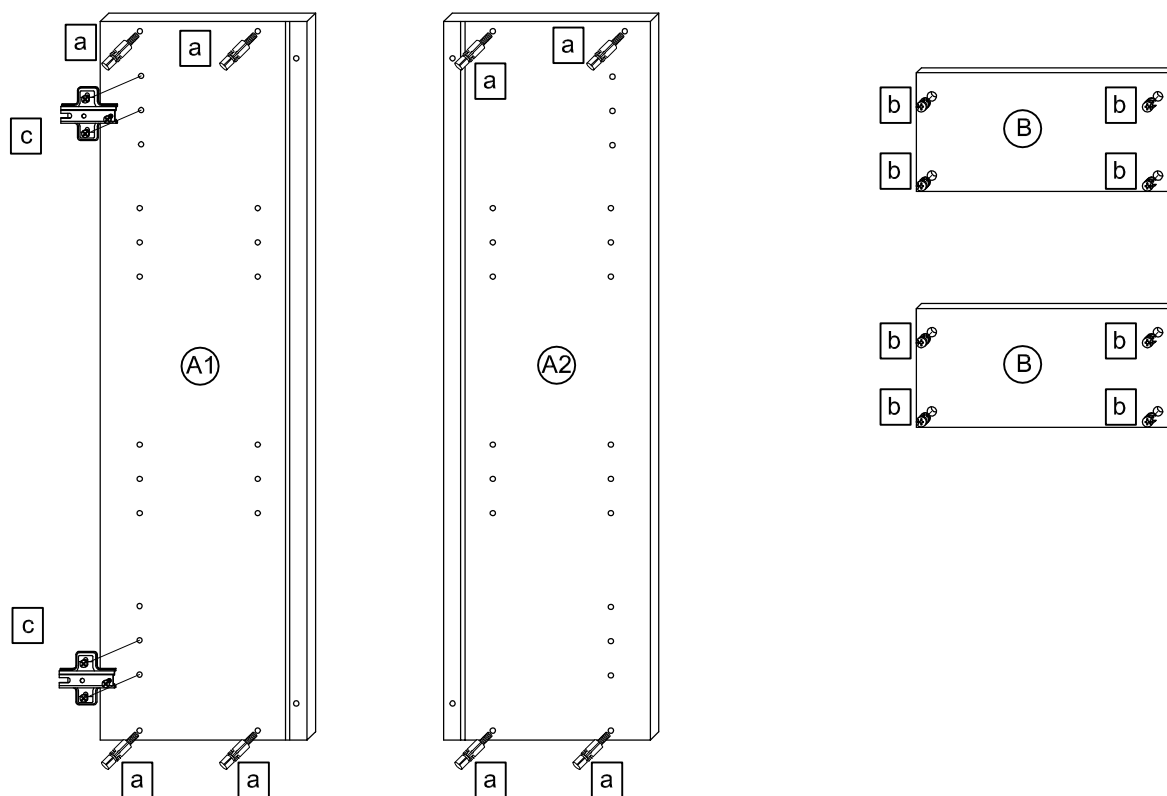
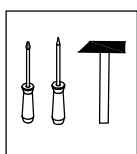

2.

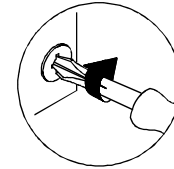
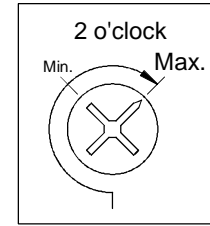
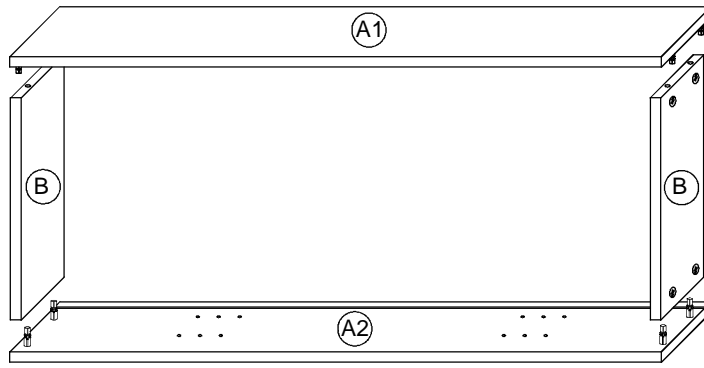
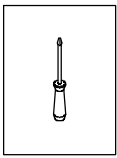

3.

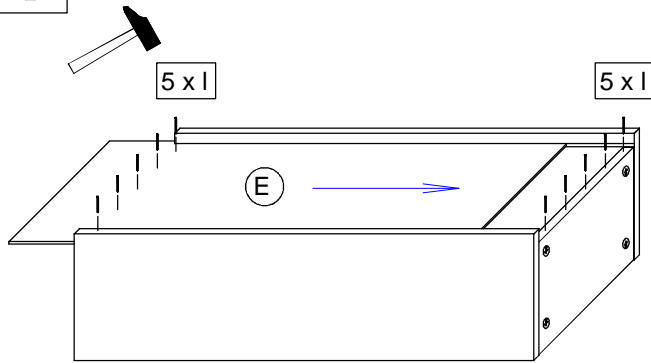
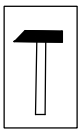

4.

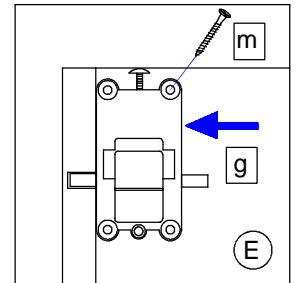
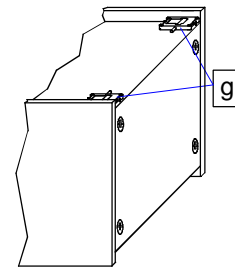
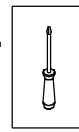

5.

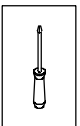

T9 Lassen Sie den Schrank nur durch fachkundige Personen mit für die Wand geeignetem Montagmaterialien montieren.

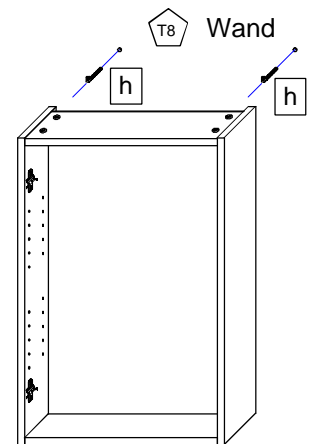
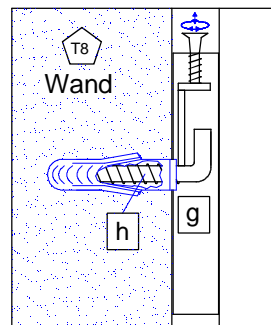

T5 Das Etikett, welches sich unten rechts befindet bitte ausschneiden und auf der Rückwand mit Klebeband (nicht beiliegend) befestigen.

PELIPAL GmbH
 Hans-Wilhelm-Peters-Straße 2

33189 Schlangen
 Germany

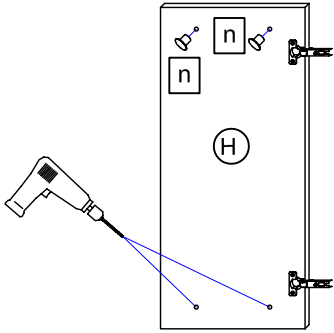
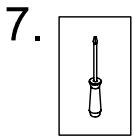
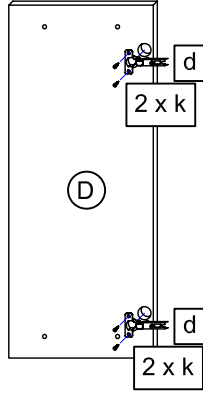
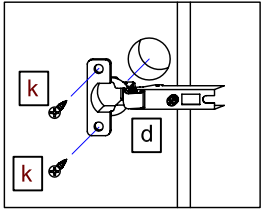
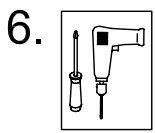

7.1

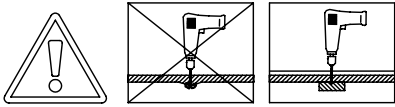

7.2

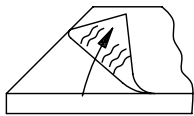

Bei Hochglanz-Fronten bitte erst die Schutzfolie entfernen und dann den Griff montieren!

7.3

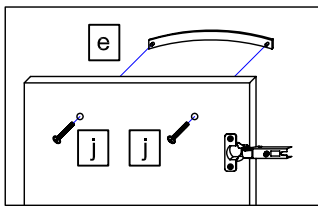

8.

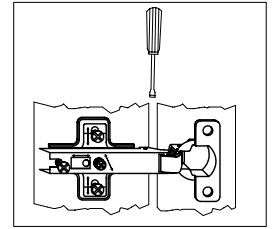
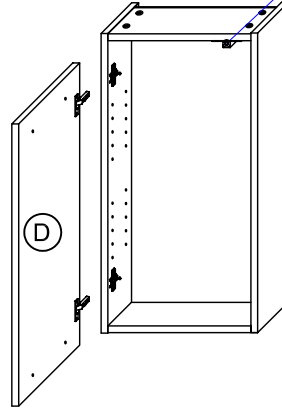
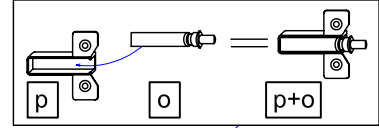
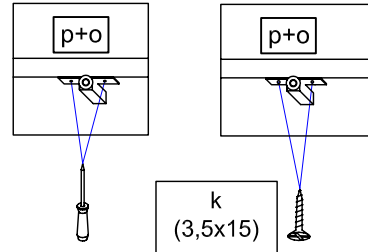
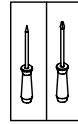

Bei Türmontage das Scharnier einhängen, bis Anschlag öffnen und anschließend festschrauben.

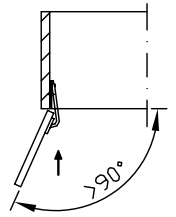

9.

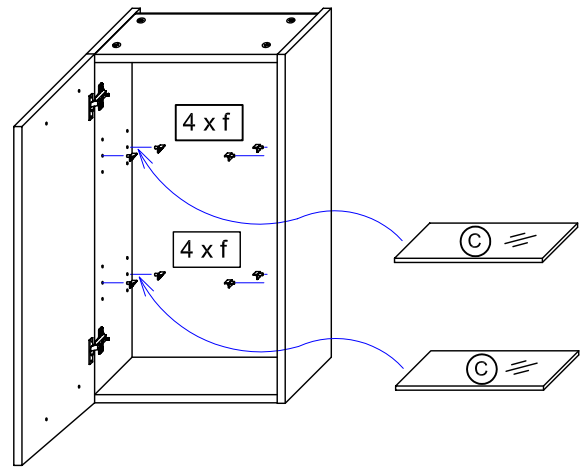

Das Möbel bitte nur mit einem feuchten Tuch reinigen.